

Linear

LINI-R RGB Fixture Guide

KKDÖ

Indoor | Recessed | RGB output

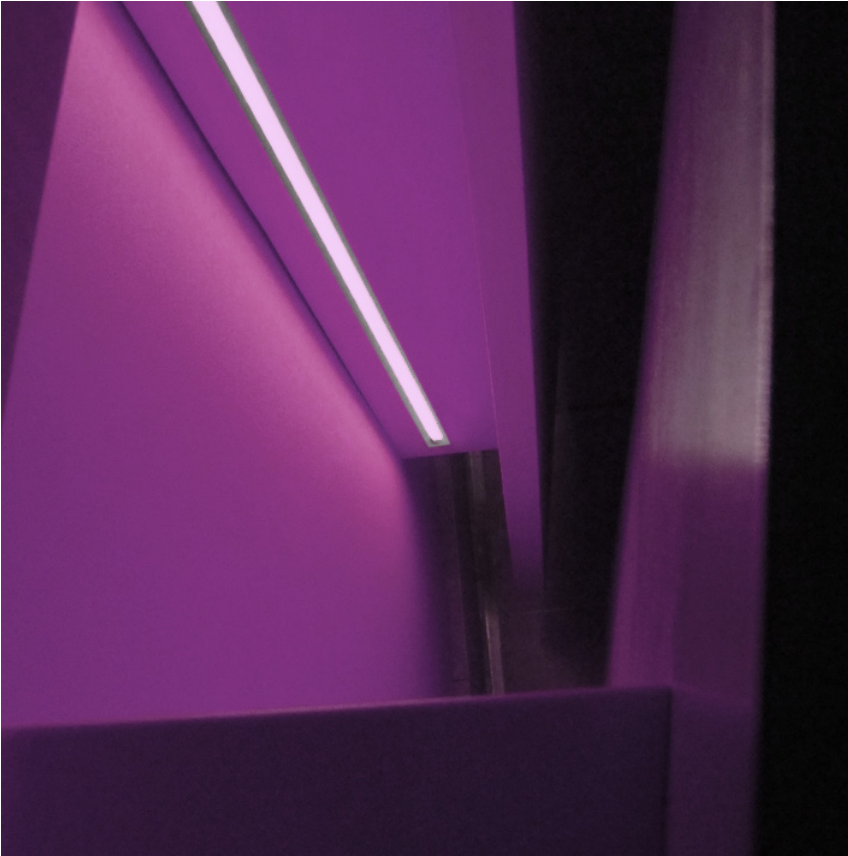

Key applications

- ✓ Ceiling
- ✓ Downlighting
- ✓ Direct lighting
- ✓ Interior

Key features

- ✓ Custom lengths
- ✓ Extensive CCT range
- ✓ Constant Voltage (CV)
- ✓ IP40 dry area
- ✓ Diffusion: homogenous
- ✓ RGB

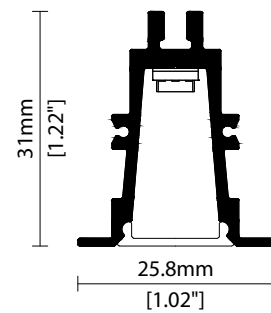

Linear

LINE-R RGB

Specification sheet

KKDÖ



Dimensions	H31/W25.8/L100-2017mm (H1.22/W1.02/L3.93-79.41in) (excluding spring clips)
PCB Cut-point	83.3mm increment/2000mm max (3.28in increment/78.74in max)
LED Pitch	13.9mm-72LED/m (0.55in - 22LED/ft)
Chip	RGB
Cover/Optics	Diffused (110°)
CCT	Red 620-625nm/Blue 455-460nm/Green 520-525nm
LED binning	5nm tolerance
CRI	N/A
Lifetime	50,000 hours @ 25°C (50,000 hours @ 77°F)
Operating temp	$T_a = -25$ to 55°C ($T_c \text{ max} = 74^\circ\text{C}$) $T_a = -13$ to 131°F ($T_c \text{ max} = 165.2^\circ\text{F}$)
IP Rating	IP40
Finish	Silver anodised
Mounting	Recessed mounting via spring clip
Power feed	Hardwire tails or male/female connectors
Control	DMX/DALI



Power consumption	Supply voltage	Supply current
15.6W/m (4.75W/ft)	24V DC	0.65A/m (0.20A/ft)

Diffused Cover

Red: 54lm/m (16lm/ft)
Green: 116lm/m (35lm/ft)
Blue: 19lm/m (6lm/ft)
RGB: 167lm/m (51lm/ft)

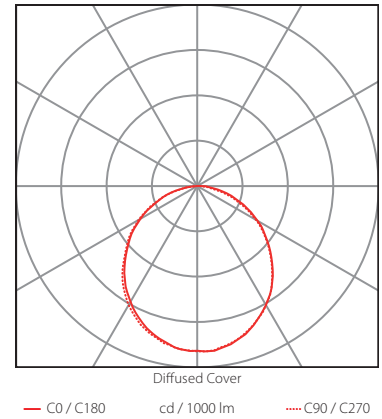
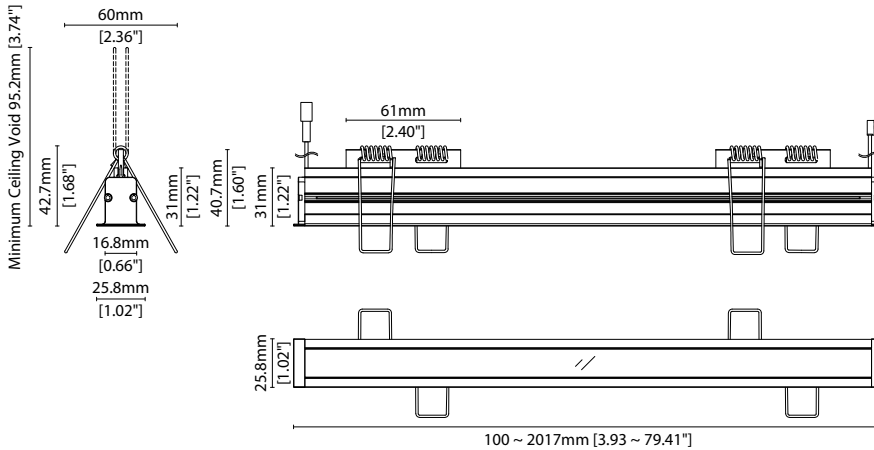

Data derived from IESNA LM-79-08 accredited testing of production samples.

See KKDC website for product document updates.

www.kkdc.lighting

LINIRRGBS-03.04EN-20240510

FIXTURE

Model	Finish	Cover ¹	Grade	LED	Colour (CCT)	Length Availability ²	IP	Cable Length	Power Feed ³	Input
LINI-R LR	Silver Anodised SA	Diffused C	 s	501	RGB RGB	m 100.3-2017mm 83.3mm increments i 3.95-79.41in 3.28in increments (Specify length code OR total run length)	IP40 40	50mm/1.97" 0050 300mm/11.81" 0300 1000mm/39.37" 1000	Single no sheath tail S00X Double no sheath tail D00X Single no sheath IP20 connector S20X Double no sheath IP20 connector D20X	DC 24V g

¹ Refer to **Cover/Lens options** on **Options** pages

² Refer to **Length Availability List** or enter total run length instead of length code

³ Refer to **Power Feed Options** on **Options** pages

Code Example:

LR	-	SA	-	C	-	s	-	501	-	RGB	-	m	517	-	40	-	0300	-	D00X	-	g
LINI-R		Silver Anodised		Diffused				501		RGB		517mm		IP40		300mm/11.81"		Double no sheath tail		DC 24V	

ACCESSORIES

Connection Accessories

KKCN-07	4 PIN RGB male & female 50mm/1.97" pair
KKCN-09	4 PIN RGB male & female 300mm/11.81" pair
KKCN-11	4 PIN RGB 300mm/11.81" extension lead

PSU/Driver

DALI/DMX

* Refer to **Driver/PSU Options** page for details or provide requirement and KKDC to offer the suitable option

* Refer to **Power feed** on **Accessories** pages

LED ENGINE VARIANTS (LED STRIP TYPE)

Colour	LED	Lumen/m	Lumen/ft	W/m	W/ft	Spec Doc	Length	Increment
Single CCT	R007	230	70	7	2.13	LINI-R R007	100-2017mm/3.93-79.41in	41.7mm/1.64in
	R014	475	145	14	4.27	LINI-R R014	100-2017mm/3.93-79.41in	41.7mm/1.64in
	R020	678	207	20	6.1	LINI-R R020	100-2017mm/3.93-79.41in	41.7mm/1.64in
Warm Dim/Dynamic White	R207	543	165	16	4.88	LINI-R R207	100-2017mm/3.93-79.41in	83.3mm/3.28in
RGB	501	Red 54 Green 116 Blue 19 RGB 167	Red 16 Green 35 Blue 6 RGB 51	15.6	4.75	LINI-R RGB	100-2017mm/3.93-79.41in	83.3mm/3.28in

* Performance data: diffused cover, RGB

LINE-R RGB

Length Availability List



Length Code		Fixture Length ¹		LED Strip ²		End Cap Dimension ³		Wattage (W)	Output (lm)			
Metric	Imperial(US)	Metric	Imperial(US)	Metric	Imperial(US)	Metric	Imperial(US)		R	G	B	W
m0100	i0004	100mm	3.95in	83mm	3.28in	12mm	0.47in	1.30	5	10	2	14
m0184	i0007	184mm	7.23in	167mm	6.56in	12mm	0.47in	2.60	9	19	3	28
m0267	i0011	267mm	10.51in	250mm	9.84in	12mm	0.47in	3.90	14	29	5	42
m0350	i0014	350mm	13.79in	333mm	13.12in	12mm	0.47in	5.20	18	39	6	56
m0434	i0017	434mm	17.07in	417mm	16.40in	12mm	0.47in	6.50	23	48	8	70
m0517	i0020	517mm	20.35in	500mm	19.69in	12mm	0.47in	7.80	27	58	10	84
m0600	i0024	600mm	23.64in	583mm	22.97in	12mm	0.47in	9.10	32	68	11	97
m0684	i0027	684mm	26.92in	667mm	26.25in	12mm	0.47in	10.40	36	77	13	111
m0767	i0030	767mm	30.20in	750mm	29.53in	12mm	0.47in	11.70	41	87	14	125
m0850	i0033	850mm	33.48in	833mm	32.81in	12mm	0.47in	13.00	45	97	16	139
m0934	i0037	934mm	36.76in	917mm	36.09in	12mm	0.47in	14.30	50	106	17	153
m1017	i0040	1017mm	40.04in	1000mm	39.37in	12mm	0.47in	15.60	54	116	19	167
m1100	i0043	1100mm	43.32in	1083mm	42.65in	12mm	0.47in	16.90	59	126	21	181
m1184	i0047	1184mm	46.60in	1167mm	45.93in	12mm	0.47in	18.20	63	135	22	195
m1267	i0050	1267mm	49.88in	1250mm	49.21in	12mm	0.47in	19.50	68	145	24	209
m1350	i0053	1350mm	53.16in	1333mm	52.49in	12mm	0.47in	20.80	72	155	25	223
m1434	i0056	1434mm	56.44in	1417mm	55.77in	12mm	0.47in	22.10	77	164	27	237
m1517	i0060	1517mm	59.72in	1500mm	59.06in	12mm	0.47in	23.40	81	174	29	251
m1600	i0063	1600mm	63.01in	1583mm	62.34in	12mm	0.47in	24.70	86	184	30	264
m1684	i0066	1684mm	66.29in	1667mm	65.62in	12mm	0.47in	26.00	90	193	32	278
m1767	i0070	1767mm	69.57in	1750mm	68.90in	12mm	0.47in	27.30	95	203	33	292
m1850	i0073	1850mm	72.85in	1833mm	72.18in	12mm	0.47in	28.60	99	213	35	306
m1934	i0076	1934mm	76.13in	1917mm	75.46in	12mm	0.47in	29.90	104	222	36	320
m2017	i0079	2017mm	79.41in	2000mm	78.74in	12mm	0.47in	31.20	108	232	38	334

¹ Actual total overall length of light fixture (LED strip + end caps + void/wire hole)

² Actual length of PCB strip

³ Actual length of 2x end caps

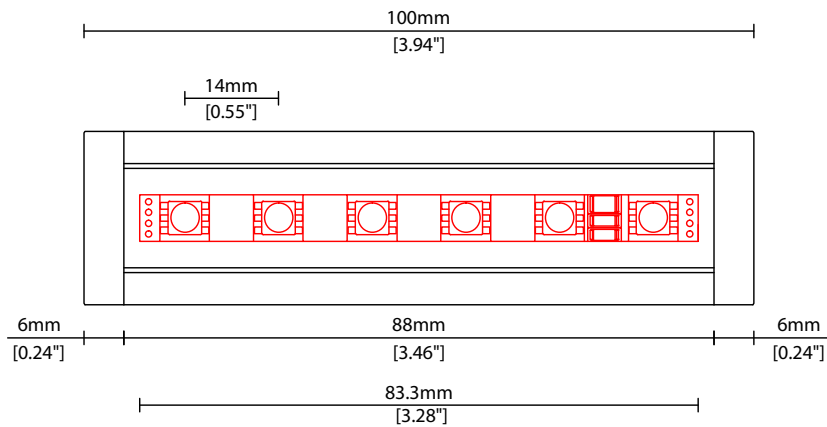



LINI-R RGB Options



COVER/LENS OPTIONS

* Options are an integral part of the fixture ordering codes. Please refer to **Code Table** pages.

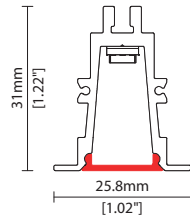

C Diffused cover
W25.8/H31mm (W1.02/H1.22")

POWER FEED OPTIONS

* Options are an integral part of the fixture ordering codes. Please refer to **Code Table** pages.

0050 S20X 50mm (1.97") Single no sheath IP20 connector

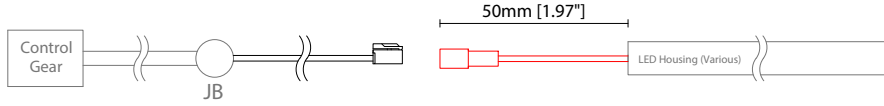

0050 D20X 50mm (1.97") Double no sheath IP20 connector

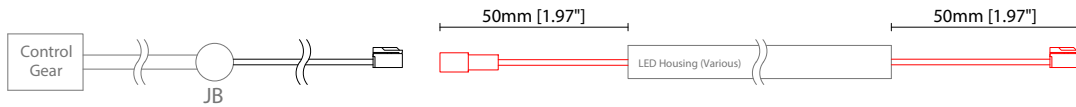

0300 S00X 300mm (11.81") Single no sheath tail

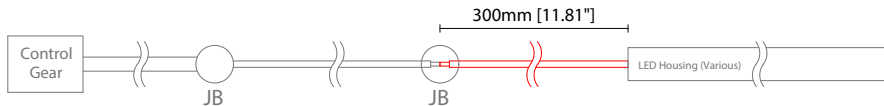

0300 D00X 300mm (11.81") Double no sheath tail

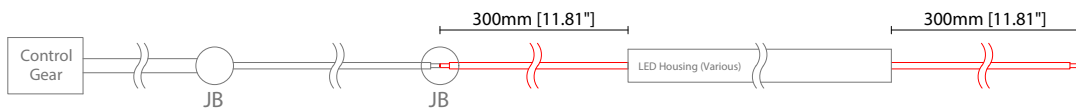

0300 S20X 300mm (11.81") Single no sheath IP20 connector

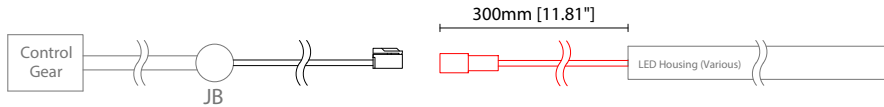

0300 D20X 300mm (11.81") Double no sheath IP20 connector

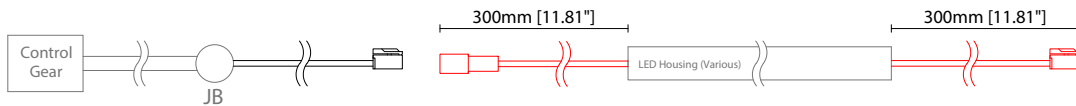

1000 S00X 1000mm (39.37") Single no sheath tail

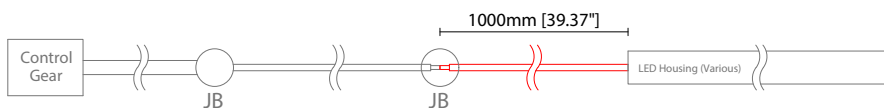

1000 D00X 1000mm (39.37") Double no sheath tail

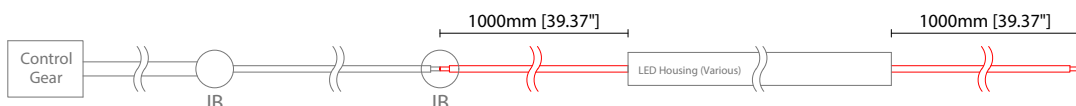

1000 S20X 1000mm (39.37") Single no sheath IP20 connector

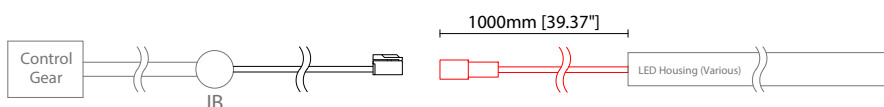

Key

Control Gear Power supply, sub-controllers & control systems

JB Junction box / cable connection

POWER FEED OPTIONS (CONTINUED)

1000 D20X 1000mm (39.37") Double no sheath IP20 connector

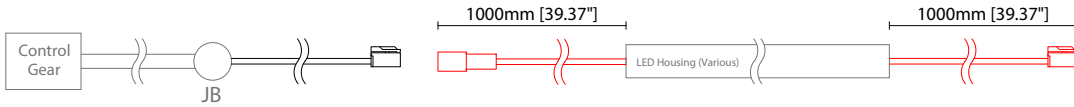

4 Pin RGB Female Connector

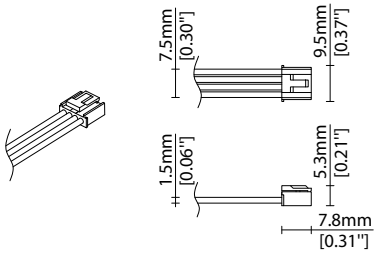

4 Pin RGB Male Connector

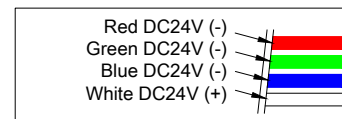
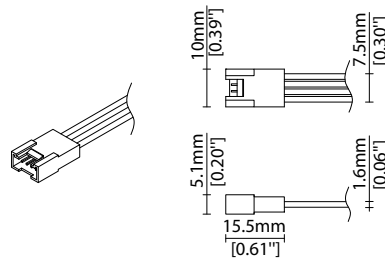

Key

Control Gear Power supply, sub-controllers & control systems
JB Junction box / cable connection

POWER FEED

Note: Accessories are to be ordered separately with corresponding code shown below.

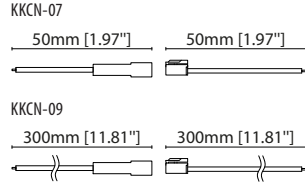

KKCN-07 50mm (1.97in) pair
KKCN-09 300mm (11.81in) pair
4 PIN RGB male + female
connector set

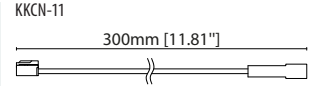

KKCN-11
4 PIN RGB 300mm (11.81in)
extension lead

KKDC CONTROL



IP20
Plastic housing
L170/W59/H29mm
(L6.69/W2.32/H1.14in)

KKDM-06 1-10V
visDIM dimmable sub-controller
(4 x 8A max @ 12-36V)



IP20
Plastic housing
L170/W53.4/H28mm
(L6.69/W2.10/H1.10in)

KKSC-05 DMX
visDIM dimmable sub-controller
(4 x 5A max @ 12-36V)



IP20
Plastic housing
L170/W59/H29mm
(L6.69/W2.32/H1.14in)

KKDL-02 DALI
visDIM dimmable sub-controller
(4 x 8A max @ 12-36V)



IP20
Plastic housing
L166/W53.4/H23mm
(L6.54/W2.10/H0.91in)

KKDL-03 DALI
visDIM dimmable sub-controller
(4 x 5A max @ 12-36V)

AVAILABLE PSU OPTIONS

Control Mode	PSU (Order Code)	Input Voltage AC	Output Voltage DC	Rated Output Current	Rated Power	Dim %	IP Rating
Switched	CEN-60-24	90-295V	24V	2.5A	60W	-	IP67
	HLG-60H-24	90-305V	24V	2.5A	60W	-	IP67
	HLG-100H-24	90-305V	24V	4.0A	100W	-	IP67
	HLG-150H-24	90-305V	24V	6.3A	150W	-	IP67
	HLG-240H-24	90-305V	24V	10A	240W	-	IP67
0-10V (1-10V)	PWM-40-24	90-305V	24V	1.67A	40W	100-0.15 (100-10)	IP67
	PWM-60-24	90-305V	24V	2.5A	60W	100-0.15 (100-10)	IP67
	PWM-90-24	90-305V	24V	3.67A	90W	100-0.15 (100-10)	IP67
	PWM-120-24	90-305V	24V	5.0A	120W	100-0.15 (100-10)	IP67
DALI	LIN100A1	120-277V	24V	1A per channel	100W	100-0.1	IP66/IP40
DMX RGB	LIN100A1	120-277V	24V	1.33A per channel	100W	100-0.1	IP66/IP40
DMX RGBW	LIN100A1	120-277A	24V	1A per channel	100W	100-0.1	IP66/IP40

Flicker Free Options - Combination of PSU+ sub-controller

Control Mode	PSU (Order Code)	Sub-controller (Order Code)	Input Voltage AC	Output Voltage DC	Rated Output Current	Rated Power	Dim %	IP Rating PSU/ Sub-controller
0-10V or 1-10V	CEN-60-24	KKDM-06	90-295V	24V	2.5A	60W	100-0.9	IP67/IP20
	HLG-60H-24	KKDM-06	90-295V	24V	2.5A	60W	100-0.9	IP67/IP20
	HLG-100H-24	KKDM-06	90-295V	24V	4.0A	100W	100-0.9	IP67/IP20
	HLG-150H-24	KKDM-06	90-295V	24V	6.3A	150W	100-0.9	IP67/IP20
	HLG-240H-24	KKDM-06	90-295V	24V	10.0A	240W	100-0.9	IP67/IP20
DALI	CEN-60-24	KKDL-02/03	90-295V	24V	2.5A	60W	100-0.1	IP67/IP20
	HLG-60H-24	KKDL-02/03	90-305V	24V	2.5A	60W	100-0.1	IP67/IP20
	HLG-100H-24	KKDL-02/03	90-305V	24V	4.0A	100W	100-0.1	IP67/IP20
	HLG-150H-24	KKDL-02/03	90-305V	24V	6.3A	150W	100-0.1	IP67/IP20
	HLG-240H-24	KKDL-02/03	90-305V	24V	10.0A	240W	100-0.1	IP67/IP20
DMX RGB	CEN-60-24	KKSC-05	90-295V	24V	2.5A	60W	100-0.9	IP67/IP20
	HLG-60H-24	KKSC-05	90-305V	24V	2.5A	60W	100-0.9	IP67/IP20
	HLG-100H-24	KKSC-05	90-305V	24V	4A	100W	100-0.9	IP67/IP20
	HLG-150H-24	KKSC-05	90-305V	24V	6.3A	150W	100-0.9	IP67/IP20
	HLG-240H-24	KKSC-05	90-305V	24V	10.0A	240W	100-0.9	IP67/IP20

¹ The items shown above cover the most frequently used specification but does not exhaust the possible options

² PSU and/or driver can be chosen from the table, or KKDC may recommend the best option upon receipt of the controls requirement and installation environment

³ Electrical shop drawing will include detailed information of PSU and relevant control drivers

⁴ Cut sheets are available on the controls section of www.kkdc.lighting or upon request